

ST. GABRIEL MAUSOLEUM / SHELTER

SEC. 4 ALL SOULS CEMETERY

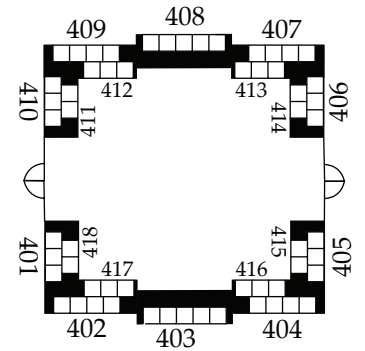
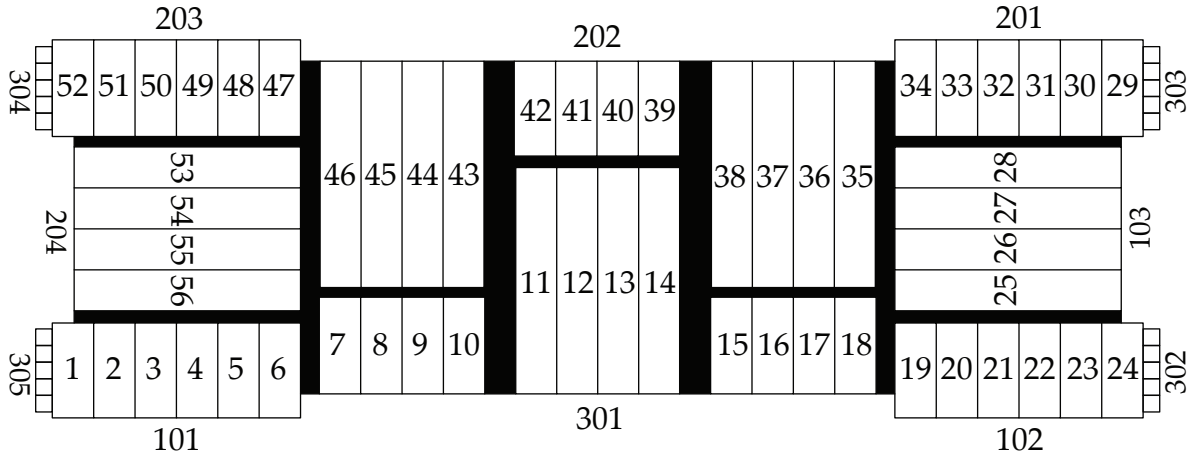

1 2 3 4 5 6 7 8 9 10 11 12 13 14 15 16 17

M
L
K
J
I
H
G
F
E
D
C
B
A

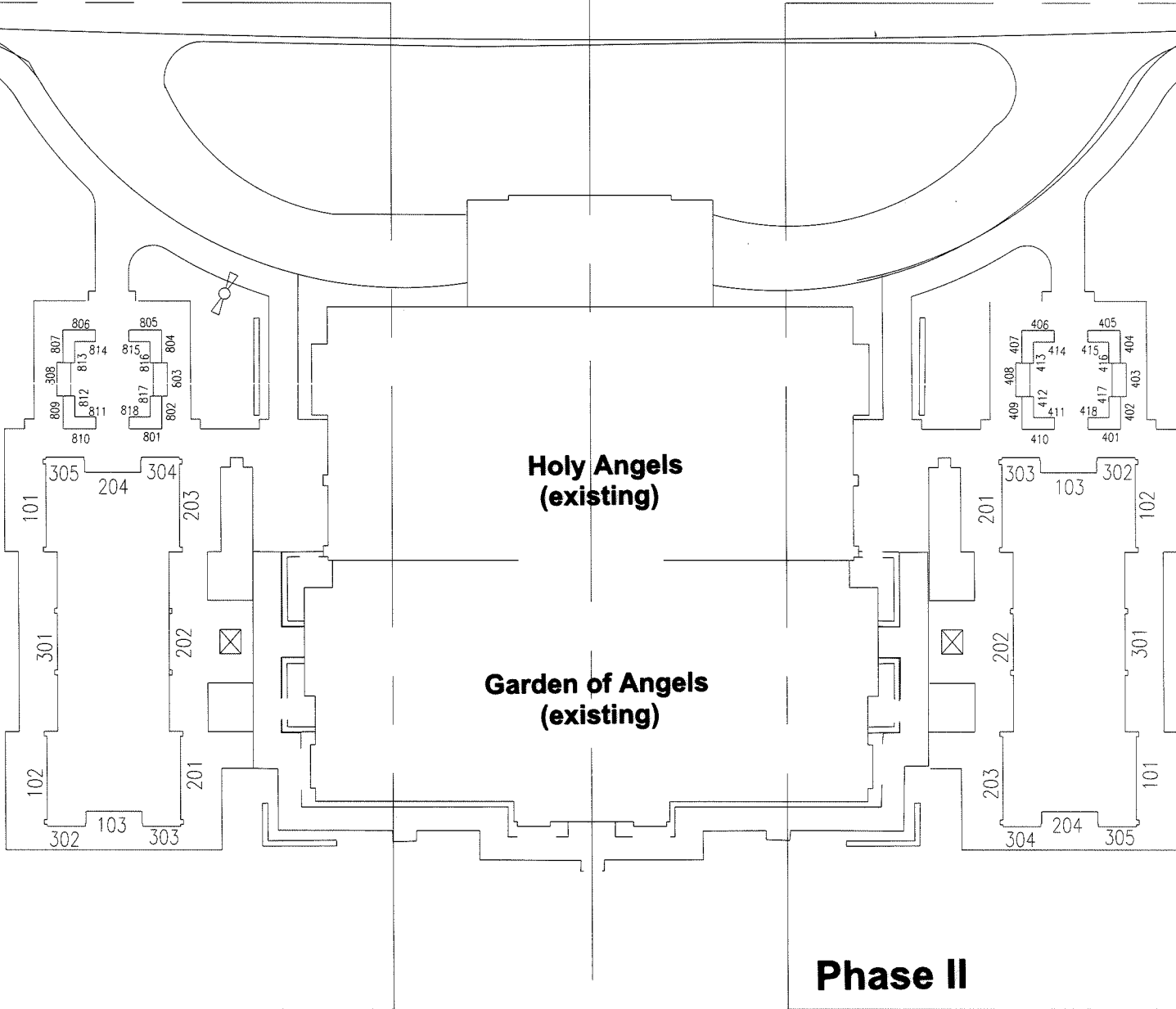

No.	DATE	REVISION

OFFICE OF DEVELOPMENT
Catholic Cemeteries Association
10000 Miles Ave. Cleveland, Ohio
44105
216.841.7975
FAX: 216.841.0212

**Mausoleum Layout
Section 4 Expansion
All Souls Cemetery**
Catholic Cemeteries Association
10366 Chardon Road

SHEET NAME:
DATE:
PROJECT No.:
2001.09

Phase I

Phase II

**Holy Angels
(existing)**

**Garden of Angels
(existing)**

A1 Site Layout Plan for Phase I and II Expansion

1"=10'0"



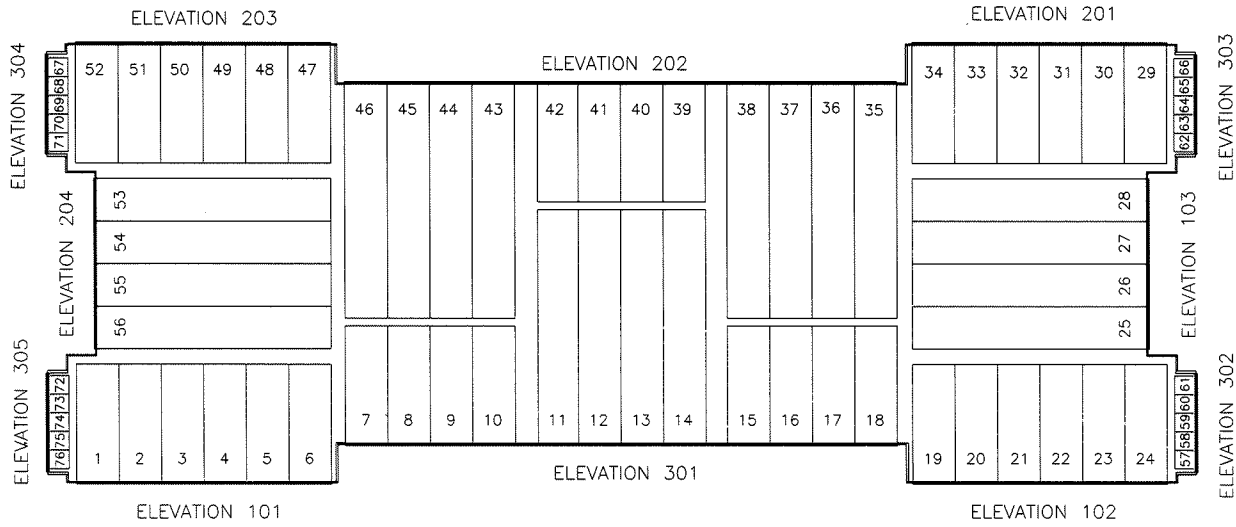

Note:
 All Crypts are designated and located by row number and tier letter.
 For example: Crypt 304 – A would be 304 and tier A.

A Designates Floor Level
 F Designates Ceiling Level

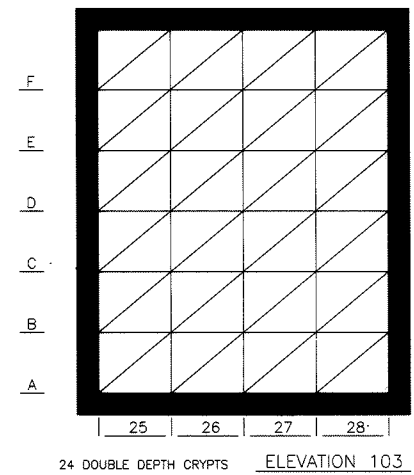
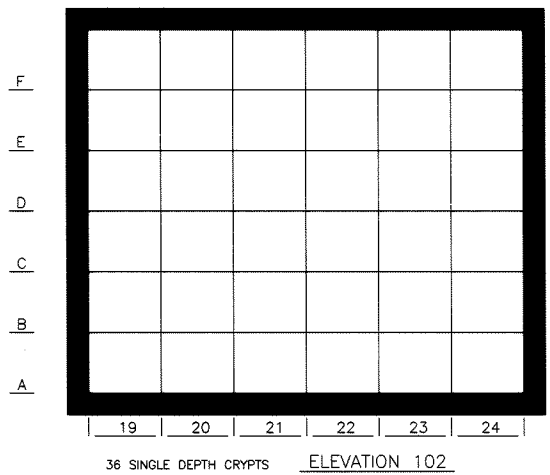
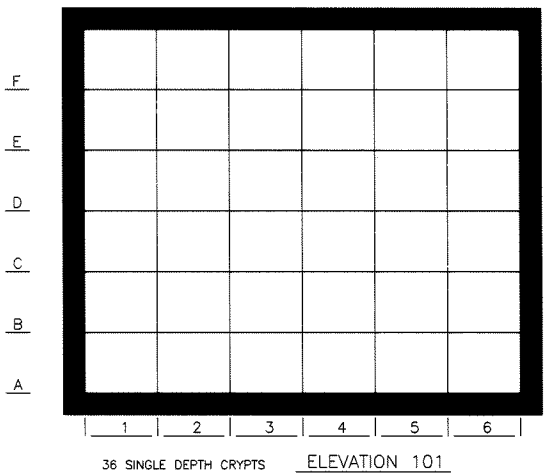

No.		DATE		REVISION	
OFFICE OF DEVELOPMENT Catholic Cemeteries Association 44100 Miller Ave. Cleveland, Ohio 218.841.7375 218.841.8212 FAX: 218.841.8212					
Saint Gabriel the Archangel Mausoleum Section 4 All Souls Cemetery Catholic Cemeteries Association 10366 Chardon Road					
SHEET NAME:					
DATE:					
PROJECT No.: 083002-4					

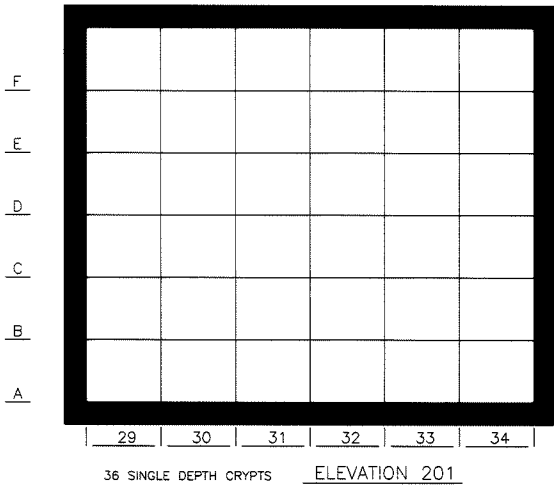

36 SINGLE DEPTH CRYPTS ELEVATION 201

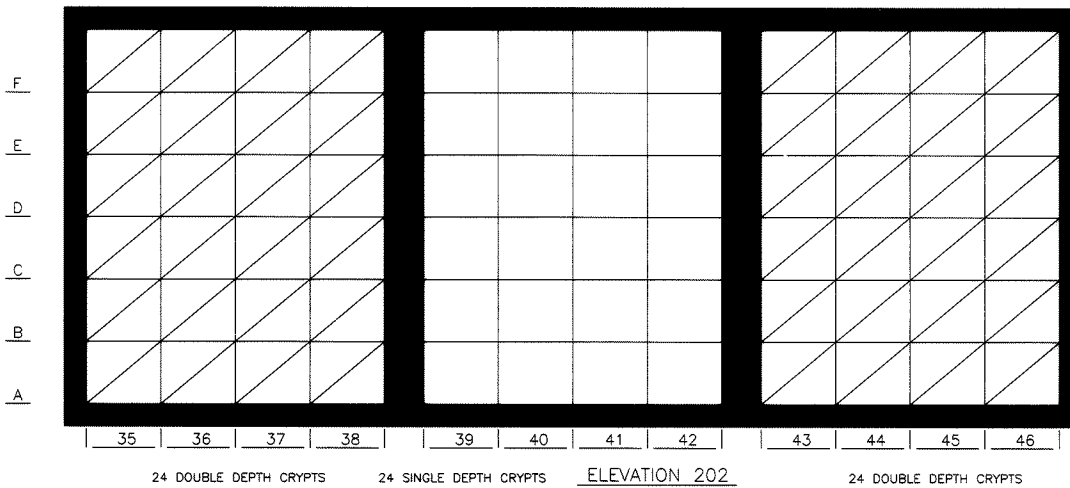

24 DOUBLE DEPTH CRYPTS 24 SINGLE DEPTH CRYPTS ELEVATION 202 24 DOUBLE DEPTH CRYPTS

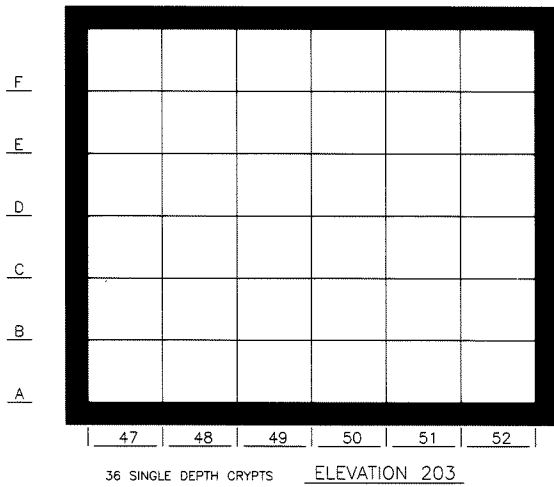

36 SINGLE DEPTH CRYPTS ELEVATION 203

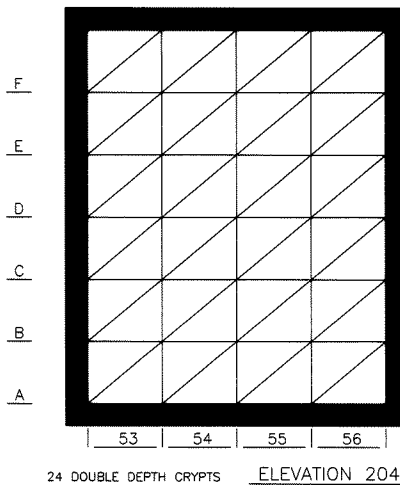

24 DOUBLE DEPTH CRYPTS ELEVATION 204

Note:
 All Crypts are designated and located by row number and tier letter. For example:
 Crypt 204 - A would be located in row 204 and tier A.

A Designates Floor Level
 F Designates Ceiling Level

No.	DATE	REVISION	M
			L
			K
			J
OFFICE OF DEVELOPMENT Catholic Cemeteries Association 18000 Miles Ave. Cleveland, Ohio 44116 216.841.7875 FAX: 216.841.8212			I
Saint Gabriel the Archangel Mausoleum Section 4 All Souls Cemetery Catholic Cemeteries Association 10566 Chardon Road			H
SHEET NAME:			G
DATE:			F
PROJECT No.: 083002-4			E
			D
			C
			B
			A

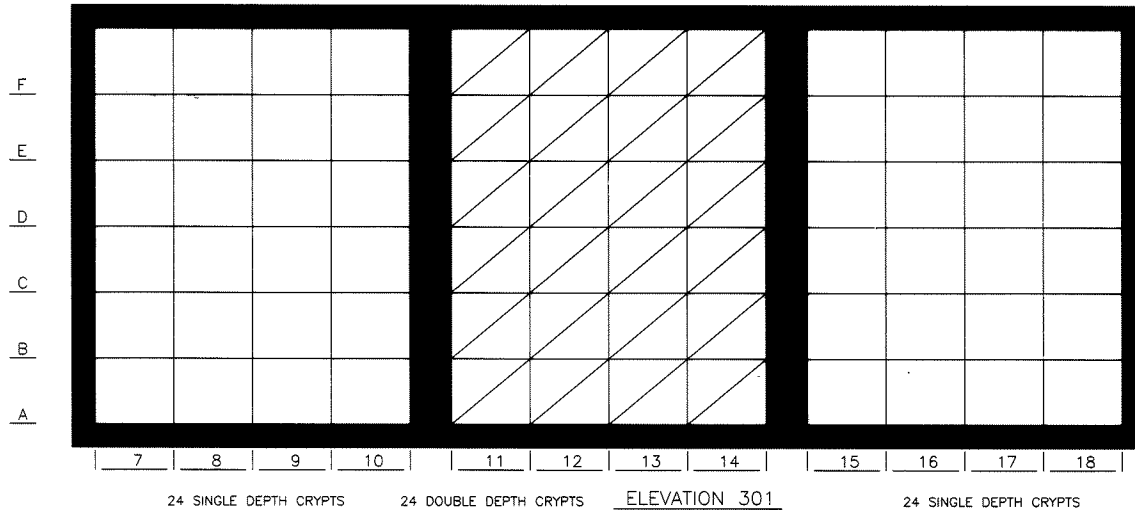

Note:
 All Crypts are designated and located by row number and tier letter. For example:
 Crypt 304 – A would be located in row 304 and tier A.

A Designates Floor Level
 F Designates Ceiling Level

24 SINGLE DEPTH CRYPTS 24 DOUBLE DEPTH CRYPTS ELEVATION 301 24 SINGLE DEPTH CRYPTS

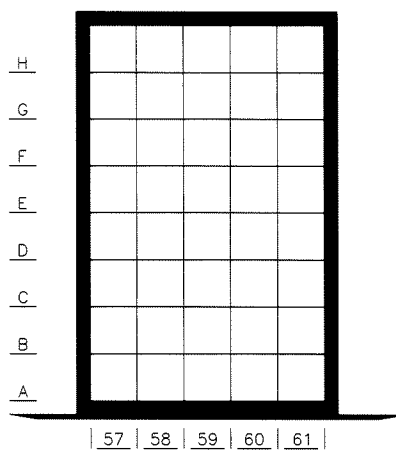

40 UNIT NICHE CABINET
ELEVATION 302

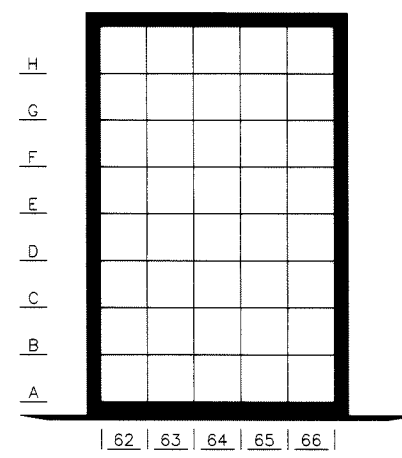

40 UNIT NICHE CABINET
ELEVATION 303

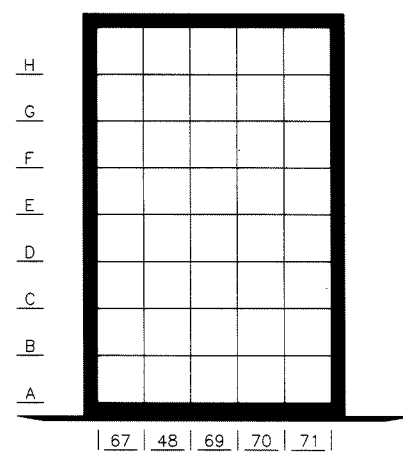

40 UNIT NICHE CABINET
ELEVATION 304

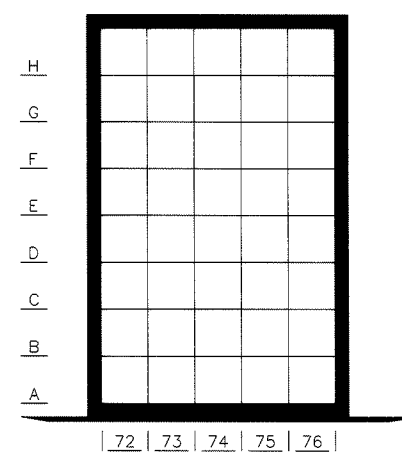

40 UNIT NICHE CABINET
ELEVATION 305

No.	DATE	REVISION	M
			L
			K
No.	DATE	REVISION	J
			I
			H
OFFICE OF DEVELOPMENT Catholic Cemeteries Association 10000 Millan Ave. Cleveland, Ohio 44105 216.841.7575 FAX: 216.841.0212			G
Saint Gabriel the Arcange! Mausoleum Section 4 All Souls Cemetery Catholic Cemeteries Association 10366 Chardon Road			F
SHEET NAME:			E
DATE:			D
PROJECT No.: 063002-4			C
			B
			A

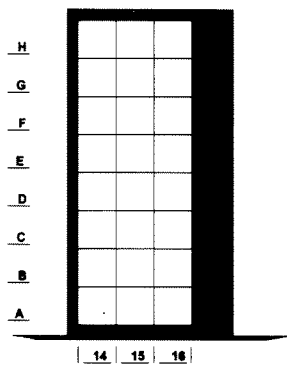
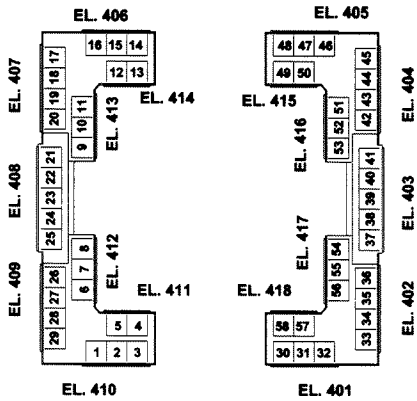

24 UNIT NICHE CABINET
ELEVATION 406

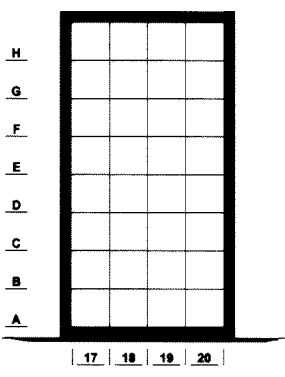

32 UNIT NICHE CABINET
ELEVATION 407

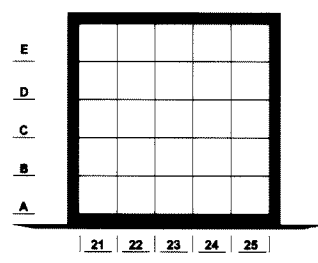

25 UNIT NICHE CABINET
ELEVATION 408

NOTE:
All niches are designated and located by row number and tier letter.
For example: Niche 18 - A would be located in row 18 and tier A.

Summary
217 Niches

A Designates Floor Level
F Designates Ceiling Level

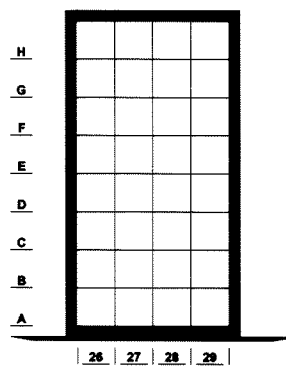

32 UNIT NICHE CABINET
ELEVATION 409

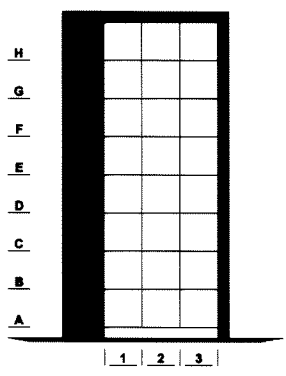

24 UNIT NICHE CABINET
ELEVATION 410

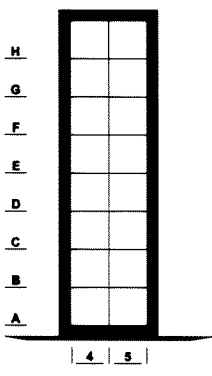

16 UNIT NICHE CABINET
ELEVATION 411

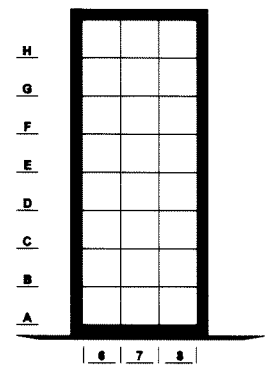

24 UNIT NICHE CABINET
ELEVATION 412

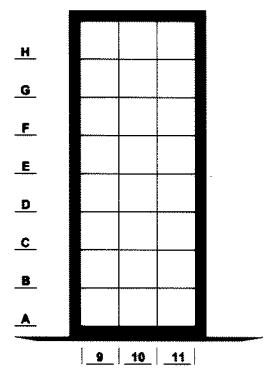

24 UNIT NICHE CABINET
ELEVATION 413

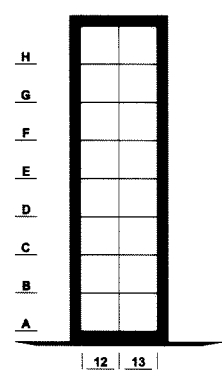

16 UNIT NICHE CABINET
ELEVATION 414

No.	DATE	REVISION	M
			L
No.	DATE	REVISION	K
			J
OFFICE OF DEVELOPMENT Catholic Cemeteries Association 19000 Miles Ave. Cleveland, Ohio 44105 216.841.7575 FAX: 216.841.0212			I
Saint Gabriel the Archangel Mausoleum Section 4 All Souls Cemetery Catholic Cemeteries Association 10366 Chardon Road			H
SHEET NAME:			G
DATE:			F
PROJECT No.: 063002-4			E
PROJECT No.: 063002-4			D
PROJECT No.: 063002-4			C
PROJECT No.: 063002-4			B
PROJECT No.: 063002-4			A

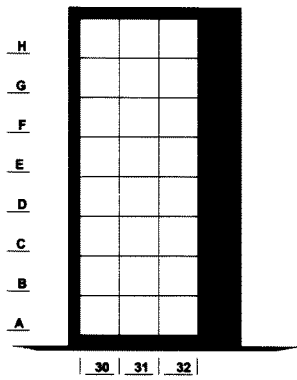
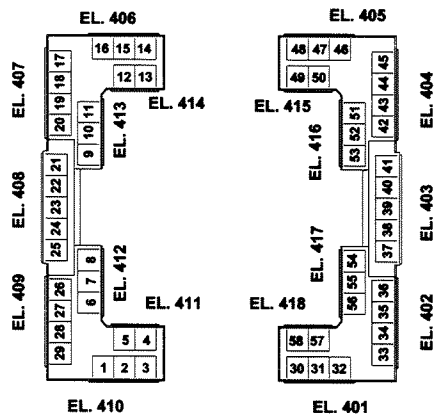

24 UNIT NICHE CABINET
ELEVATION 401

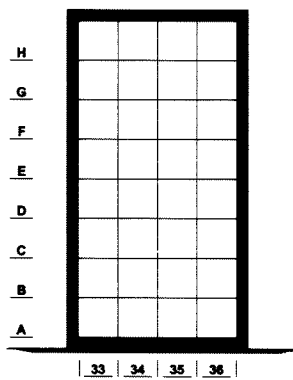

32 UNIT NICHE CABINET
ELEVATION 402

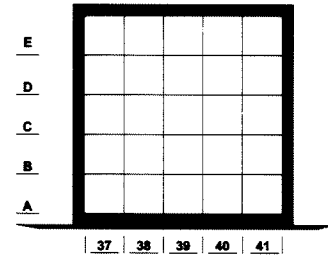

25 UNIT NICHE CABINET
ELEVATION 403

NOTE:
All niches are designated and located
by row number and tier letter.
For example: Niche 36 - A would be
located in row 36 and tier A.

Summary
217 Niches

A Designates Floor Level
F Designates Ceiling Level

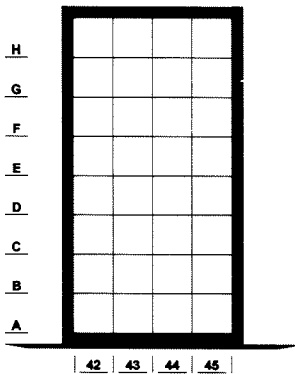

32 UNIT NICHE CABINET
ELEVATION 404

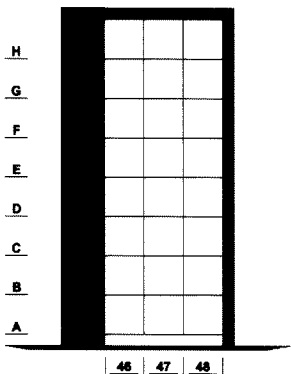

24 UNIT NICHE CABINET
ELEVATION 405

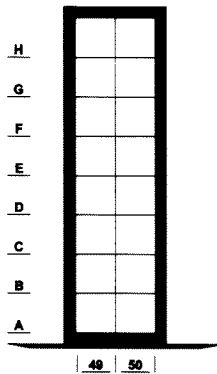

16 UNIT NICHE CABINET
ELEVATION 415

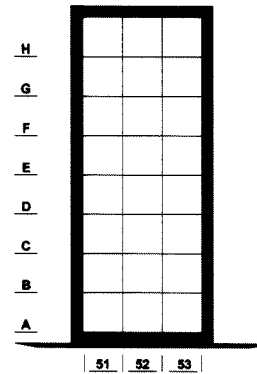

24 UNIT NICHE CABINET
ELEVATION 416

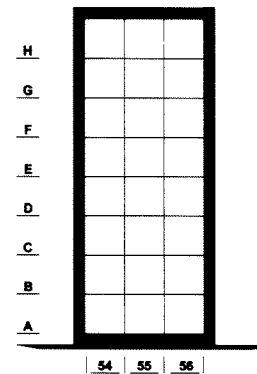

24 UNIT NICHE CABINET
ELEVATION 417

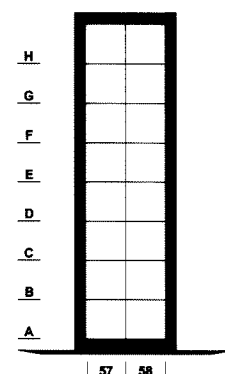

16 UNIT NICHE CABINET
ELEVATION 418

No.	DATE	REVISION

OFFICE OF DEVELOPMENT
Catholic Cemeteries Association
10092 Miles Ave. Cleveland, Ohio
21166 - 1775.
21166 - 1775.
FAX: 216.441.0212

**Saint Gabriel the Archangel Mausoleum
Section 4
All Souls Cemetery**
Catholic Cemeteries Association
10366 Chardon Road

SHEET NAME:

DATE:
PROJECT No.:
083002

M
L
K
J
I
H
G
F
E
D
C
B
A